

PK 200002 L SH

DELICATE ASSEMBLY JOBS AND HEAVY- DUTY APPLICATIONS ARE WHAT IT DOES BEST

LIFETIME EXCELLENCE



LIFETIME EXCELLENCE

PALFINGER loader cranes are convincing due to their superior life-cycle performance. They are the most economical and also the most reliable over the entire product life. From solution finding to resale.

- **Better solutions**
- **Better efficiency**
- **Better ergonomics**
- **Higher availability**
- **More reliability**
- **Better ecology**
- **Higher serviceability**
- **Higher value retention**



PERFECT WORKING EQUIPMENT

- High mobility due to the mounting on standard truck chassis
- Very stiff and light boom system thanks to new P-Profile
- Hydraulic lifting height of roughly 49 meters thanks to long boom design
- Additional applications with Power Link Plus
- High working speed thanks to double circuit control
- Maximum precision and safety due to AOS
- Special stabiliser concept with extendable rear stabiliser ram
- Maximum utilisation of the working range thanks to extended HPSC
- More efficiency with fly-jib due to DPS Plus





FIRST-RATE IN DESIGN AND PERFORMANCE

15 Highlights



Continuous slewing system

Unrestricted movement

More efficient in operation due to faster loading cycles, since the crane can be slewed over a shorter distance. The crane works more efficiently and faster.



Power Link Plus

High variety of uses

With the 15 degree reverse linkage system on the knuckle boom and the 25 degree reverse linkage system fly-jib, you can reach through low door openings and also work inside buildings. Heavy crane work – even in difficult conditions.

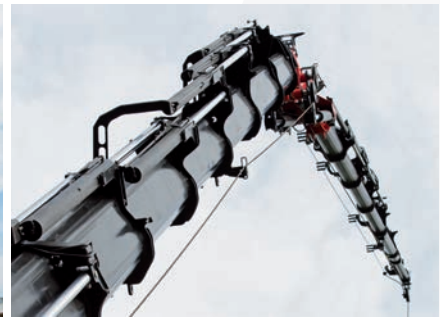

Extension boom system

Excellent stability, even at a height

Thanks to the use of high-strength fine-grain structural steels in combination with a new extension boom profile, stiffness is increased and weight reduced.

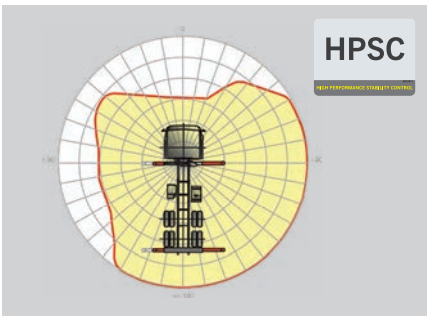

HPSC

Maximum utilisation of the working range

The variable stabiliser positioning of the High Performance Stability Control System allows the full lifting capacity of the crane to be used, even when working within tight spaces.

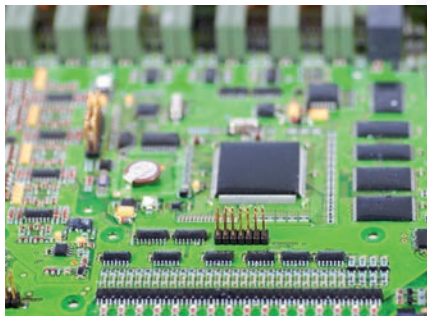

S-HPLS

More lifting power when it counts

S-HPLS is one of the most important functions of the PALTRONIC 150. It is a fully automatic system for increasing lifting power. The lifting power and crane speed can be continuously adapted to suit requirements.



PALcom P7

Communication with the operator

The new PALcom P7 features a modern, ergonomic design. The centrally located knob „PALdrive“ and a large colour display enables easy and safe operation.



Cable winch

Additional possible applications

The 4.5-tonne winch features high lifting power.



Functional design

Practical and attractive

Robust plastic covers protect crane parts against dirt and damage. Improved looks and increased operational comfort – throughout the entire lifetime.

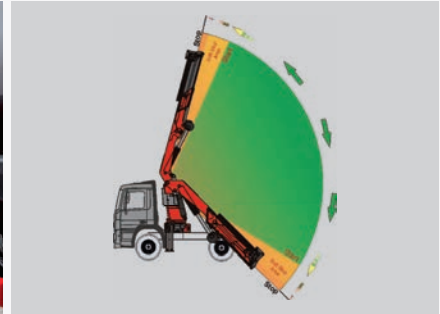

Soft Stop function

Improved comfort and safety

The Soft Stop function is an electronic limit position damper. It causes gentle braking of all crane movements before the limit position is reached. Hence, jerky movements and load impacts can be avoided. The crane can be operated more gently and precisely.

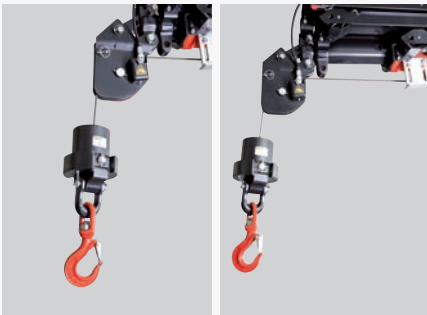

SRC

More comfort in rope winch operation

The SRC (Synchronised Rope Control) system maintains a constant distance between the pulley head and the hook block. This advantage is particularly valuable in terms of ease use for the operator, and it also noticeably improves the efficiency of any operation.

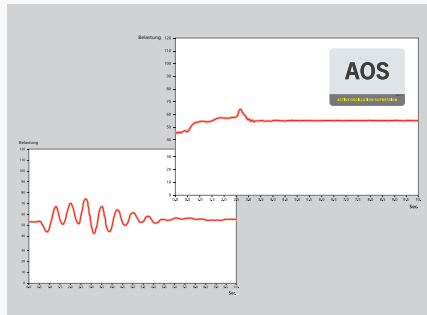

AOS

Maximum precision and safety

The active oscillation suppression system prevents „post-oscillation“ in the event of rapid braking or load changes. The stress peaks on the extension boom system are reduced and material fatigue and wear are minimized. This increases the resale value.



DPS Plus

More efficient fly jib operation

The Dual Power System allows multiple uses of the crane both for large outreaches as well as for heavy load operation.



Workman basket

Maximised functionality

With the aid of the workman basket, additional duties like installation and maintenance work can be performed with the crane.



Stabiliser concept

Operation in restricted spaces

The PK 200002 L SH has four-way stabilisers with full sensor monitoring. An additional front stabiliser cylinder and an extendible rear stabiliser cylinder integrated into the frame of the crane complete the stabiliser concept.



Mounting concept

A one-stop solution

PALFINGER offers its customers complete solutions from the factory via the Mounting Competence Center. This allows mounting to be standardised and optimised on a conventional 4-axle or even a 5-axle truck.



MAXIMUM PRECISION

In a newly constructed office complex, there are five large winter gardens at a height of 30 metres. These gardens feature impressive palm trees and grevillea trees with a height of eight metres. The individual parts had to be lifted with millimetre accuracy through an open segment of the window on the eighth floor into the interior of the office complex.





PK 200002 L SH

HIGH PERFORMANCE

More lifting power when it is really needed.

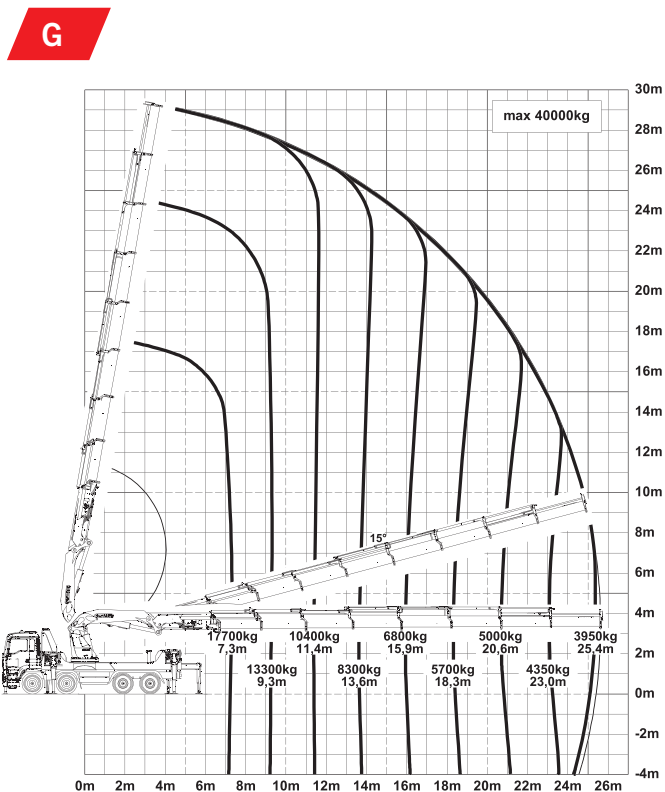
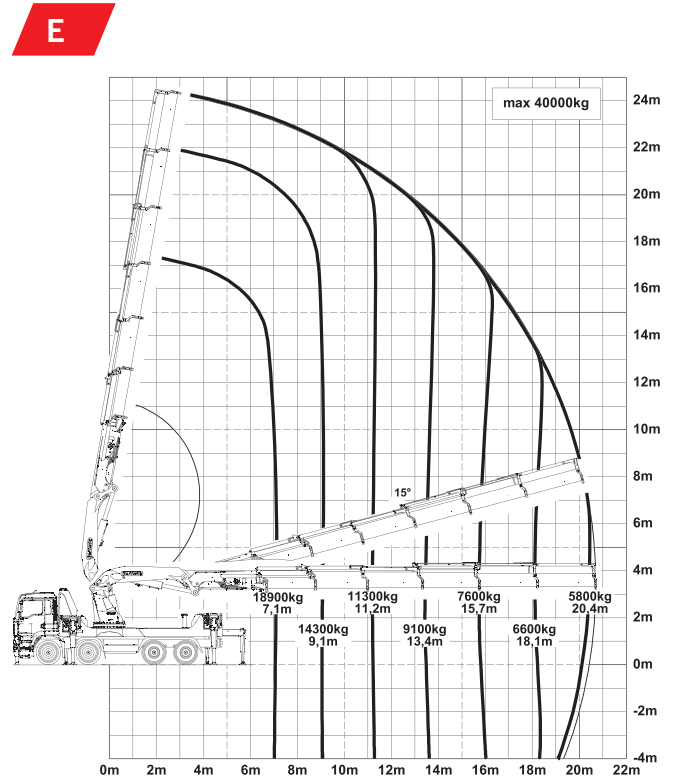
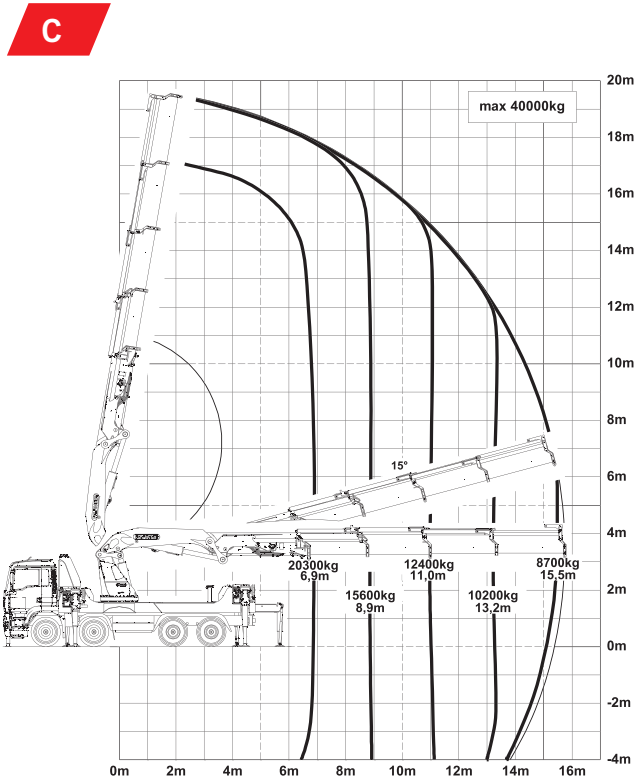

The outreaches stated are with a boom angle of 20° and are therefore not the maximum.

Lifting capacities

max.		40000 kg/392.4 kN	88,200 lbs	C
6.9 m	23 ft	20300 kg/199.1 kN	44,700 lbs	
8.9 m	29 ft	15600 kg/153.0 kN	34,300 lbs	
11.0 m	36 ft	12400 kg/121.6 kN	27,400 lbs	
13.2 m	43 ft	10200 kg/100.1 kN	22,600 lbs	
15.5 m	51 ft	8700 kg/85.3 kN	19,200 lbs	

max.		40000 kg/392.4 kN	88,200 lbs	E
7.1 m	23 ft	18900 kg/185.4 kN	41,600 lbs	
9.1 m	30 ft	14300 kg/140.3 kN	31,600 lbs	
11.2 m	37 ft	11300 kg/110.9 kN	24,800 lbs	
13.4 m	44 ft	9100 kg/89.3 kN	20,100 lbs	
15.7 m	52 ft	7600 kg/74.6 kN	16,800 lbs	
18.1 m	59 ft	6600 kg/64.7 kN	14,400 lbs	
20.4 m	67 ft	5800 kg/56.9 kN	12,700 lbs	

max.		40000 kg/392.4 kN	88,200 lbs	G
7.3 m	24 ft	17700 kg/173.6 kN	39,000 lbs	
9.3 m	30 ft	13300 kg/130.5 kN	29,400 lbs	
11.4 m	37 ft	10400 kg/102.0 kN	22,800 lbs	
13.6 m	45 ft	8300 kg/81.4 kN	18,200 lbs	
15.9 m	52 ft	6800 kg/66.7 kN	15,000 lbs	
18.3 m	60 ft	5700 kg/55.9 kN	12,600 lbs	
20.6 m	68 ft	5000 kg/49.1 kN	10,900 lbs	
23.0 m	76 ft	4350 kg/42.7 kN	9,600 lbs	
25.4 m	83 ft	3950 kg/38.7 kN	8,700 lbs	

Technical specifications

EN 12999 HC1 HD5/S1

Max. lifting moment	150.7 mt/1478 kNm	1090030 ft.lbs
Max. lifting capacity	40000 kg/392.3 kN	88200 lbs
Max. hydraulic outreach	25.6 m	83' 12"
Max. outreach (with fly-jib)	47.9 m	157' 3"
Slewing angle	endless	
Slewing torque	12.5 mt / 122.6 kNm	90390 ft.lbs
Stabiliser spread	10.4 m	34' 1"
Max. operating pressure	385 bar	5583 psi
Recommended pump capacity	2 x 120 l/min	31.7 US gal./min

PK 20002 L SH

HIGH PERFORMANCE

G PJ300LF DPS PLUS

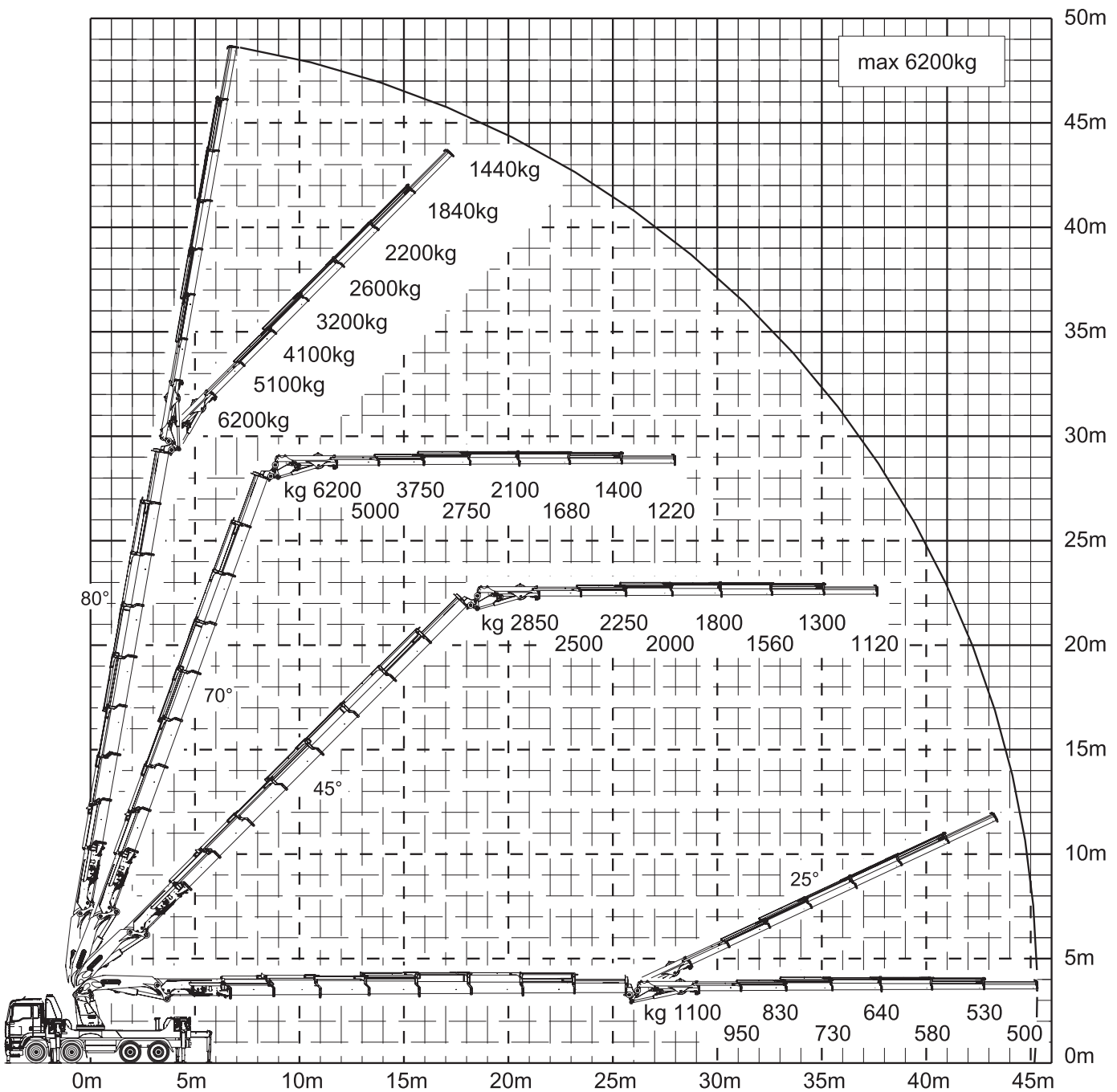

Extension boom G(8) fully extended

MOUNTING-OPTIONS



Platform

On the basis of a standardised platform, different platform variants are offered. The design of the front, rear and side walls is individually adapted to the preferred variant. The steel parts of the platform design feature KTL coating and are painted in the customer's preferred colour.



Design of rear cover panel

The cover panel is slightly rounded on the corners of the vehicle and finishes off the vehicle with an attractive design. The rear stabiliser is covered with a flush-mounted cover. The interior spaces in the rear cover are a perfect place to stow lashing equipment or lifting straps.



Front stabiliser

A front stabiliser can be added in order to maximize the overall performance of the vehicle. If required, this can also include the necessary chassis frame reinforcement. The front stabiliser cover is accurately matched to the front-end shape of the relevant truck.



Storage system

A standard holder is available for all components of the crane gear, for dunnage and for other miscellaneous accessory components. In order to reduce set-up times, the holders are positioned in the best possible place for removal of the gear. This enables the crane driver to set up the crane without additional help.



Additional lighting

In order to optimise the lighting for the vehicle environment and the stabilizer area around the vehicle, modern LED working lights, for the license plate and for the periphery can be fitted on request. This not only increases your vehicle's visual appeal but also improves working safety when there is not much natural light available.



Tool and storage boxes

Starting with a specially designed box with a roller shutter and a pull-out drawer, all gaps and spaces in the vehicle can be filled with storage boxes. This maximises the stowage space on the vehicle.



Workman basket storage

For safe transportation of the workman basket, a place to store the workman basket can be mounted at the factory in conjunction with the rear panel at the rear of the vehicle.

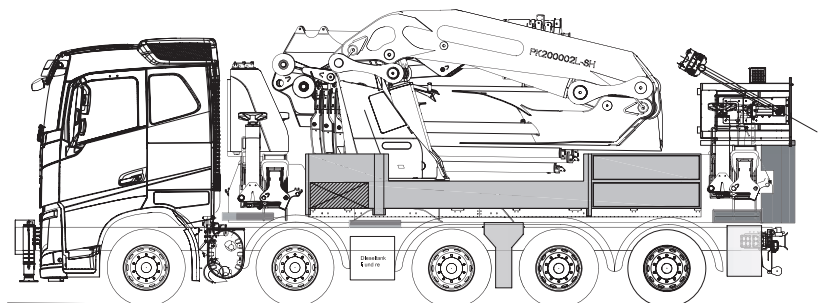

MOUNTING-EXAMPLES



Switzerland
MAN TGS 10x4 BL



Switzerland
Scania G450 10x5 BL



Germany
Scania R500 10x4 LL

Spain
VOLVO 10x4



USA
Westernstar 10x4



Israel
Scania R480 8x4 BB





KP-HPK200002SM3+EN

Cranes shown in the leaflet are partially optional equipped and do not always correspond to the standard version. Country-specific regulations must be observed. Dimensions may vary. Subject to technical changes, errors and translation mistakes.